

# SETTING UP the Sun StorEdge™ 5310 NAS

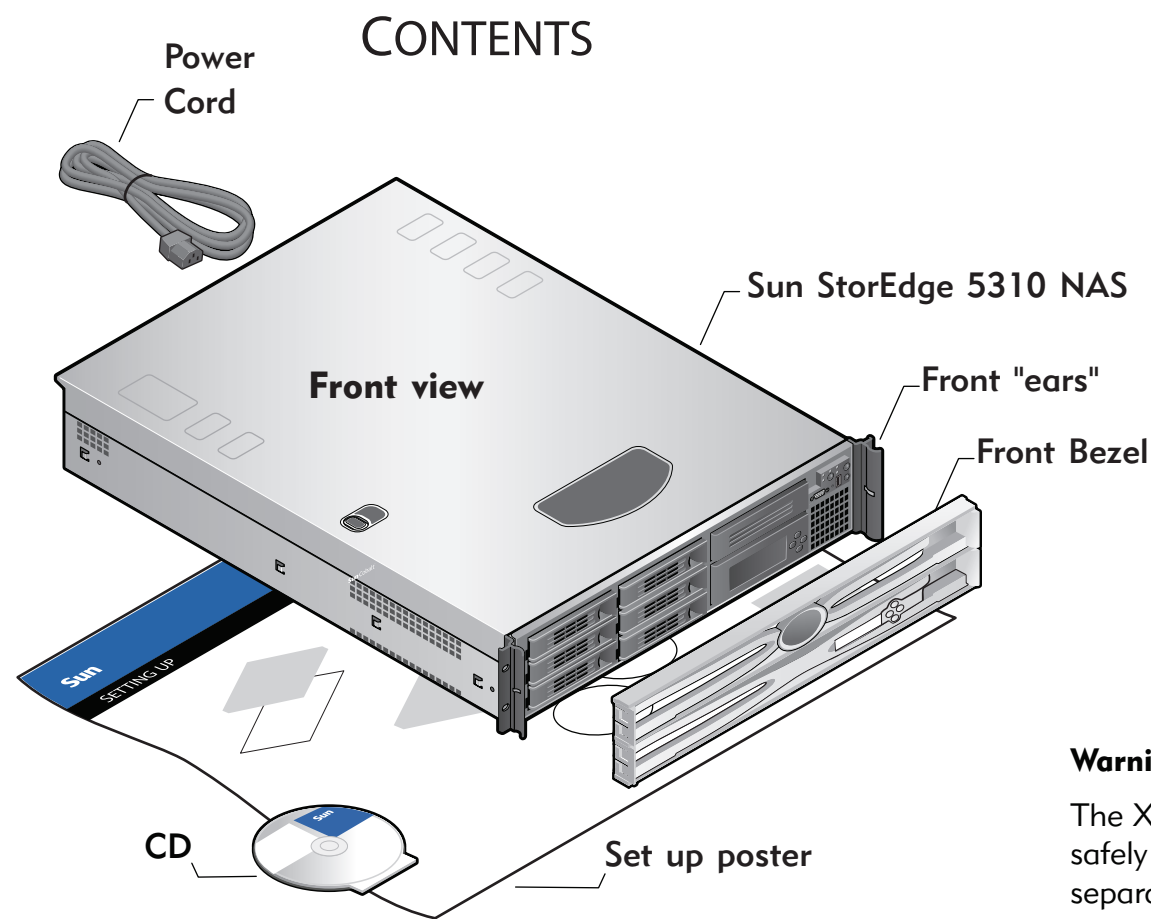

**Warning:**

The X5030A slide rail kit is required to safely mount this unit. The kit is sold separately.

Detailed installation instructions are included with the kit.

Using a kit other than the X5030A could create a safety hazard or damage the system or cabinet.

**The front "ears" hold the bezel. Do not use them for rack mounting.**

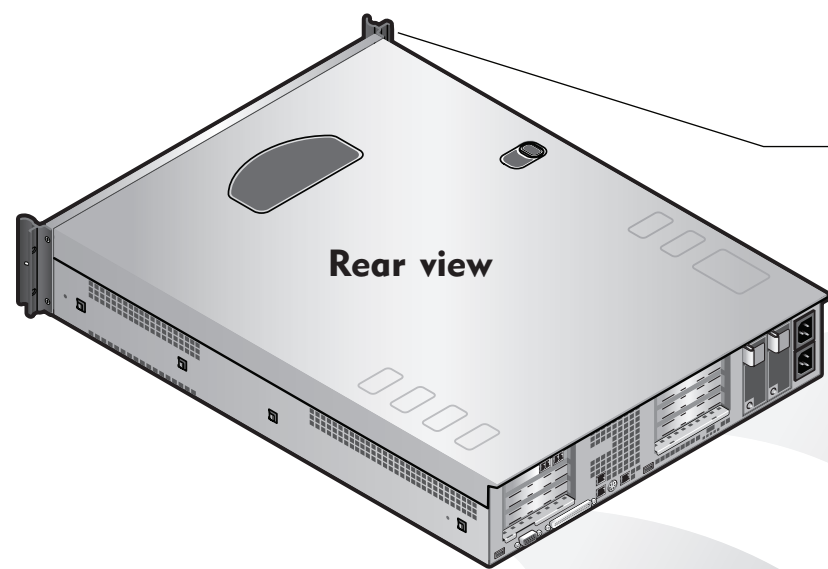

**CABLING**

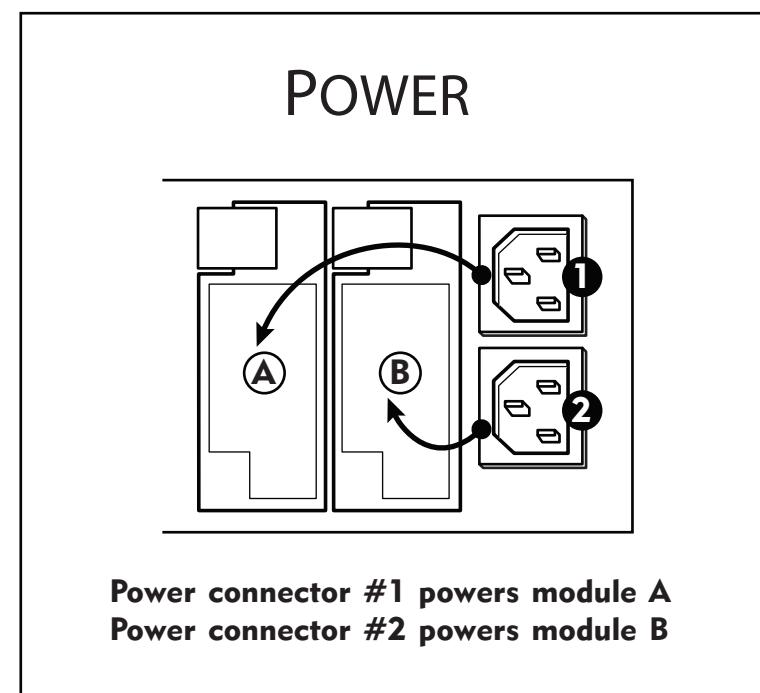
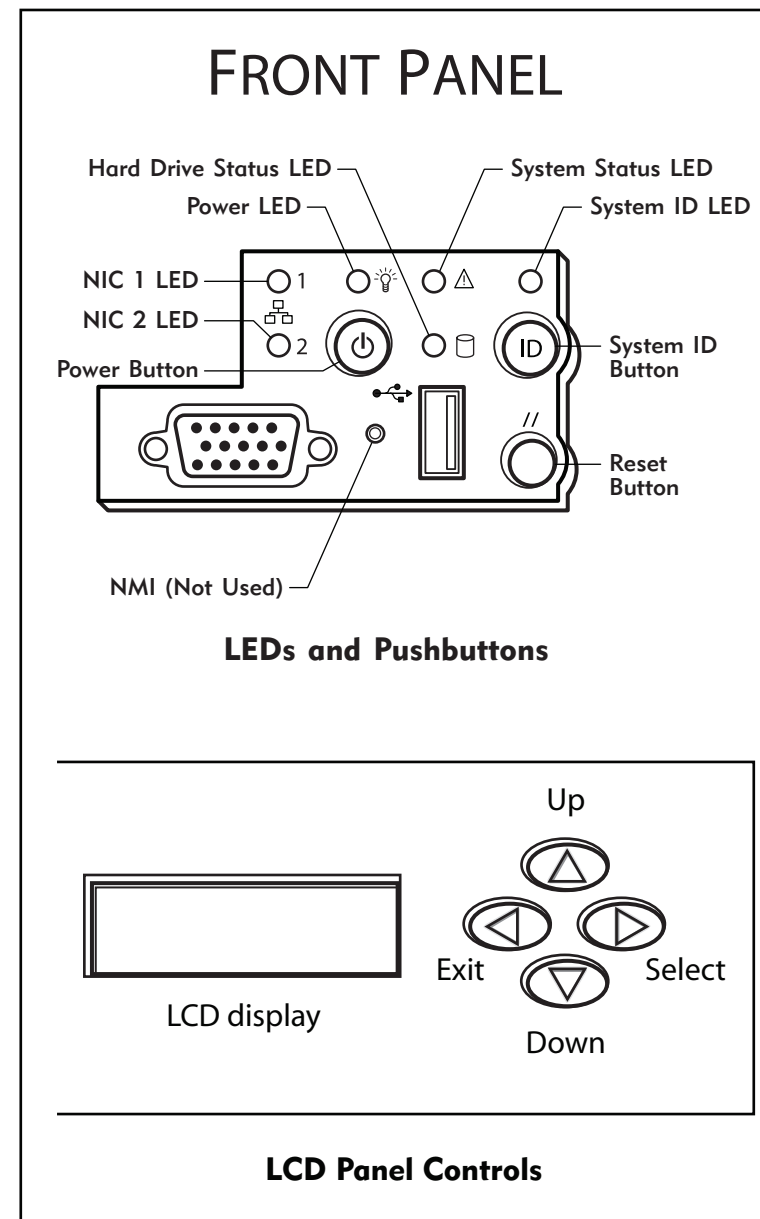
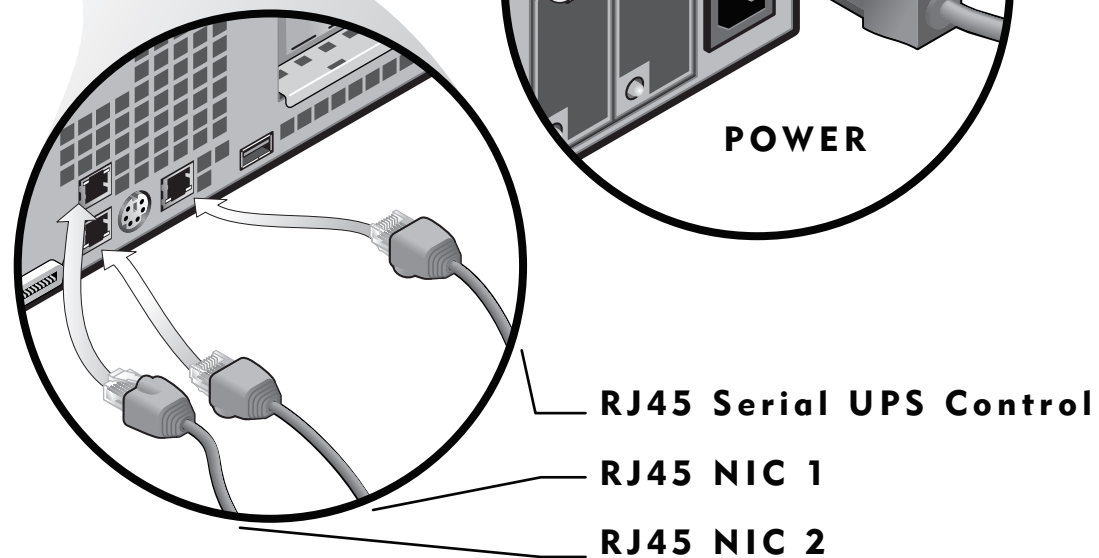

## POWERUP

Follow storage installation instructions on the other side of this poster before powering up the system.

*NOTE: Always power on the units in the following order:*

1. If present, expansion enclosure(s) first.
2. RAID EU controller tray next.
3. Sun StorEdge 5310 NAS last.

1. Power on the EU-F expansion enclosure(s) (if present) power switches and allow the hard drives to spin up for a minute. If you do not have any EU-F expansion enclosure(s), skip to the next step.

2. Power on the RAID EU controller tray power switches.

3. Turn on the Sun StorEdge 5310 NAS by pressing its power switch.

If the IP address is automatically configured using DHCP, skip Network Setup without DHCP and go to System Configuration.

## NETWORK SETUP without DHCP

If your network does not support DHCP, follow these steps to manually configure the IP address using the LCD Panel Controls:

1. After the system has booted up, press the Select button once, then select Set Static IP.

2. Enter or accept the values listed below, then using the Select button move the cursor to the far right to save them:

- \* IP Address
- \* Subnet mask
- \* Broadcast Address
- \* Gateway Address (if necessary)

## SYSTEM CONFIGURATION

Using a separate system with a Java™-enabled browser connected to the network:

1. Make sure the network link LED is green.

2. Enter the IP address of the Sun StorEdge 5310 NAS

*NOTE: You must use a Java-enabled browser. If not already installed, the Configuration Wizard prompts you to allow your browser to install the Java plug-in from the Internet. Click Yes.*

After installing the Java plug-in, it takes about 45 seconds for the Login page to load. Check browser settings to confirm that no proxy server is enabled or that it is bypassed for local network addresses.

3. Click Apply to log in (no passwords are required at this point). The system displays the End-User agreement.

4. Click Accept Agreement to continue. The system prompts you to start the Configuration Wizard.

5. Click Next to start the Configuration Wizard.

6. Follow the steps in the Configuration Wizard to complete the system setup.

# Attaching the Sun StorEdge™ 5310 NAS, 5300 RAID EU, and 5300 EU-F

Before you can use the Sun StorEdge 5310 NAS, you must attach it to the RAID EU and the EU-Fs (if present).

**Caution** — • Connect all cables before powering up the systems.  
 • When you power off the RAID EU or EU-F, wait ten seconds before you power it back on.  
 • Always power up the systems in the order described on the front of this poster under "POWERUP!"

### Wiring for two HBA cards

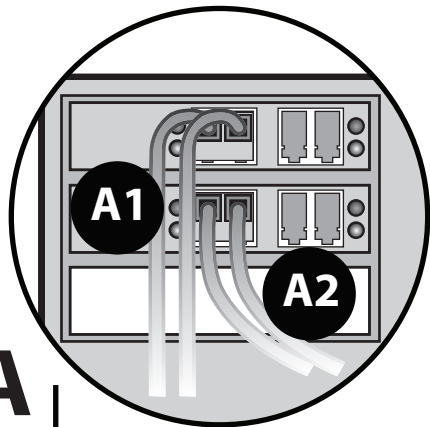

Sun StorEdge 5310 NAS connected to a 5300 RAID EU and a single EU-F Expansion Enclosure

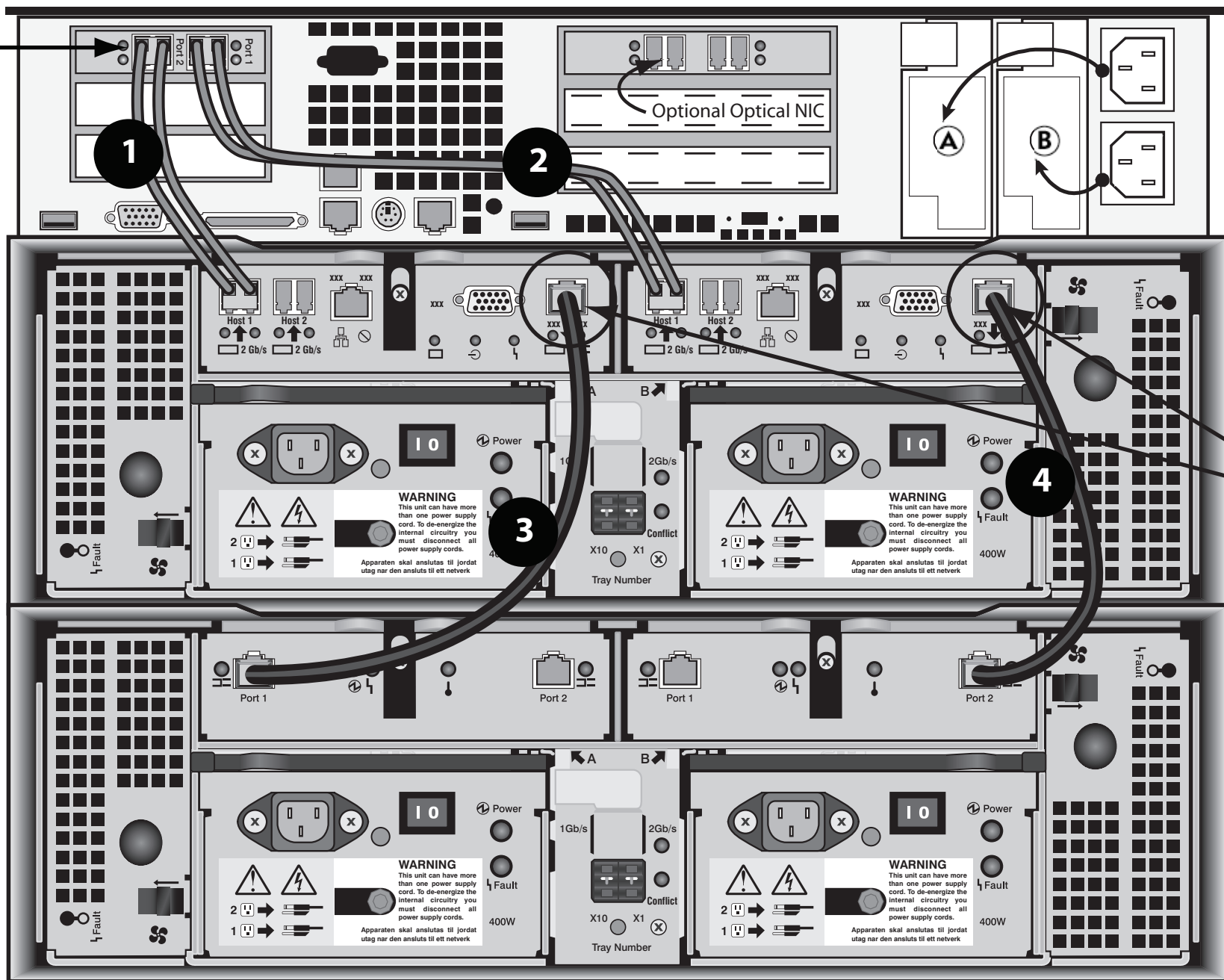

Power connector #1 powers module A  
 Power connector #2 powers module B

### Expansion Ports

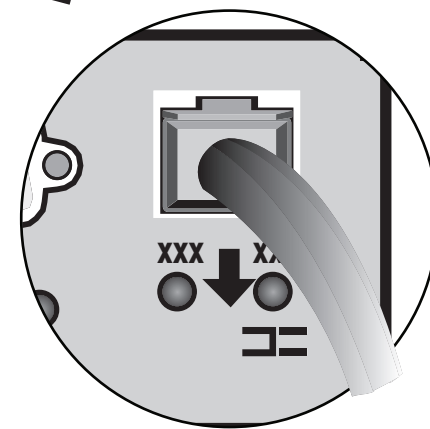

### Connecting the 5310 NAS to a 5300 RAID EU Controller Tray

The 5310 NAS and one 5300 RAID EU connect through a pair of Optical Fiber cables. Connect the HBA port 2 on the server to the left module "Host 1" port on the RAID EU (1). Connect the HBA port 1 on the server to right module "Host 1" port on the RAID EU (2).

If you have two HBA cards, refer to callout A. Connect the first HBA port 2 (A1) to the left module "Host 1" port on the RAID EU. Connect the second HBA port 2 (A2) to the right module "Host 1" port on the RAID EU. If you are connecting two 5300 RAID EUs please refer to the Sun StorEdge 5310 NAS Hardware Installation, Configuration, and User Guide.

### Connecting a Single EU-F Expansion Enclosure

The EU-F expansion enclosure connects to the RAID EU controller tray through a pair of Active Copper cables. Connect the RAID EU's left module expansion port to "Port 1" on the left module of the EU-F (3). Connect the RAID EU's right module expansion port to "Port 2" on the right module of the EU-F (4). If you are connecting multiple EU-Fs please refer to callout B.

The RAID EU Tray Number is set to "0." Each EU-F must be set to a different number. Use the Tray Number thumb wheels to set the EU-Fs to "1" for the first, "2" for the second, and so on.

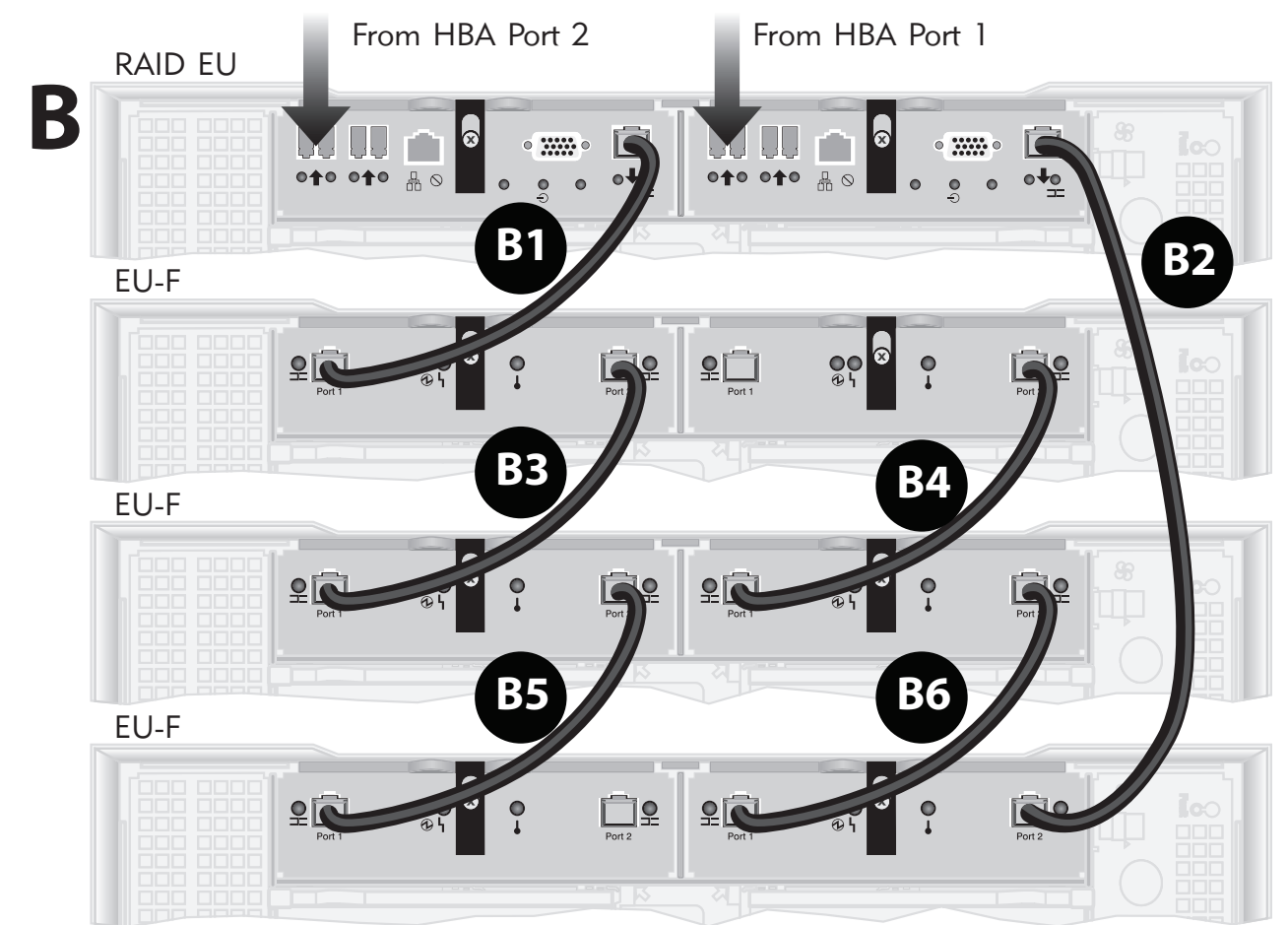

### Connecting Multiple EU-F Expansion Enclosures

Each EU-F Expansion Enclosure is connected through a pair of Active Copper cables.

Connect the RAID EU's left module right expansion port to "Port 1" on the left module of the top EU-F (B1).

Connect the RAID EU's right module right expansion port to "Port 2" on the right module of the bottom EU-F (B2).

Each EU-F connects to the EU-F below it: the left module "Port 2" connects to the next EU-F left module "Port 1" (B3), (B5), and so on. The right module "Port 2" connects to the next EU-F right module "Port 1" (B4), (B6), and so on.

Units should be rack-mounted from the **bottom up**, starting with any EU-F(s), then the RAID EU, then the NAS.

For product documentation for the Sun StorEdge 5310, please go to [http://www.sun.com/products-n-solutions/hardware/docs/Network\\_Storage\\_Solutions/storage\\_appliances/index.html](http://www.sun.com/products-n-solutions/hardware/docs/Network_Storage_Solutions/storage_appliances/index.html)

Refer to the "POWERUP" instructions on the other side of this poster.